

QUICK-START GUIDE

GEMINI SLATE 4

serato



Installation and Setup

The Gemini Slate 4 is a class compliant USB plug and play device and requires no further driver installation on Mac OSX, but may require drivers for Windows. Please visit your hardware manufactures website for the latest driver downloads.

NOTE: Please ensure you have the latest available drivers AND firmware updates, which may be required in order to be compatible with Serato DJ. Please visit the hardware manufacturers website for downloads.

1. Download and install the latest version of Serato DJ from <http://serato.com/dj/downloads>
2. After installing drivers, connect your Slate 4 to an available USB Port.
3. Open Serato DJ.
4. The Slate 4 platters require a few touches by the user in order to calibrate to their environment. After power up and start of Serato DJ, tap the platters a few times to set their sensitivity.

Serato DJ Activation

The Gemini Slate 4 requires an activation licence to be purchased before it can be used with Serato DJ. To find out how to activate Serato DJ by either starting your free 14 day trial, or purchasing a license for Serato DJ, [click here](#) for the most up to date information.

serato



Controller

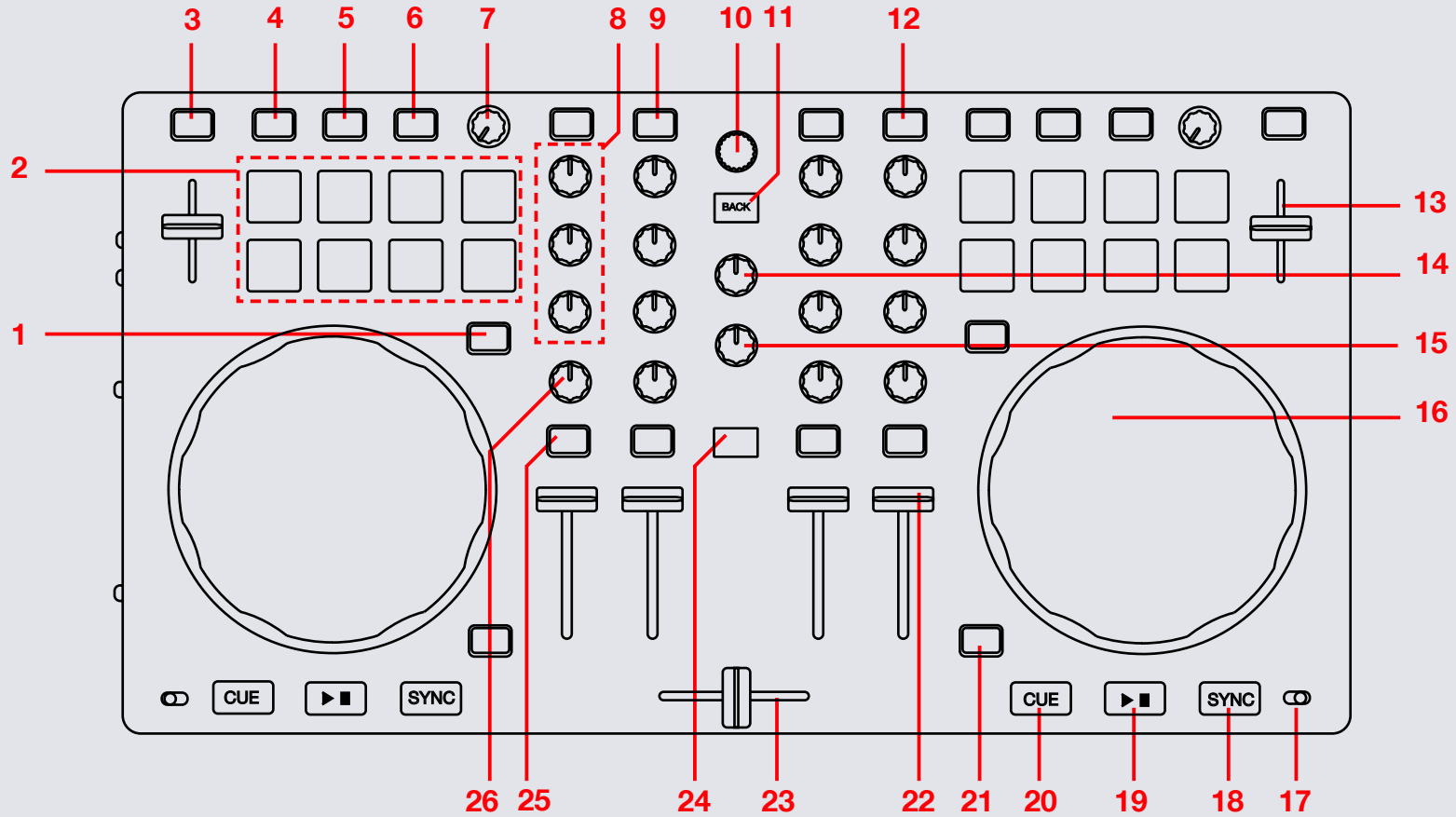

NOTE: SHIFT button is used with other buttons that have shift modifier functions.

#	Slate 4 Control	Serato DJ Function	Shift Function
1	PAD MODE	Change Performance Pad mode	
2	PERFORMANCE PADS	SEE PERFORMANCE PAD SECTION FOR MORE INFORMATION	
3	KEY LOCK	Enables Serato DJ keylock	Toggle available pitch range
4	FX 1	Turn FX slot on	Select slot effect
5	FX 2	Turn FX slot on/adjust single FX parameter	Select slot effect
6	FX 3	Turn FX slot on/adjust single FX parameter	Select slot effect
7	LEVEL	Adjust FX depth level	Adjust beat multiplier timing
8	CHANNEL EQ	Adjust Channel EQ	
9	LOAD	Load highlighted track to primary deck (1,2)	
10	BROWSE	Browse library and Serato DJ areas	
11	BACK	Toggle back to crate view or library	
12	LOAD	Load highlighted track to secondary deck (3,4)	
13	TEMPO FADER	Adjust track tempo	
14	MASTER VOL	Adjust master output volume	
15	CUE VOL	Adjust cue output volume	
16	PLATTER/JOG WHEEL	Used to control the waveform of the track in Serato DJ	Beat skip
17	DECK SEL	Switch between primary and secondary decks	
18	SYNC	Enables Sync	Turn Sync Off
19	PLAY/PAUSE	Play/Pause	
20	CUE	Play from Temporary Cue	Stutter Play/Cue previous track
21	VINYL	Enable vinyl/scratch jog mode	Enable Slip
22	CHANNEL FADER	Control channel volume	
23	CROSSFADER	Crossfade audio between channels	
24	SHIFT	Shift is used with other controls that have SHIFT modifier functions	
25	CHANNEL CUE	Monitor track channel through headphones	
26	FILTER	Channel LP/HP filter	

serato



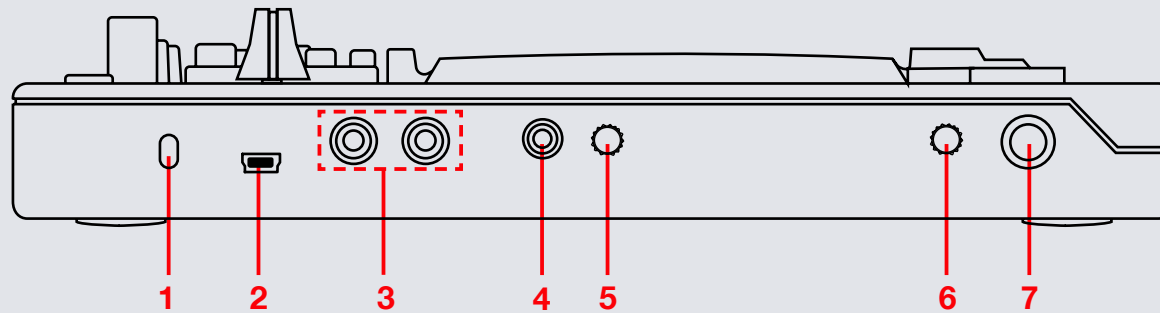

NOTE: SHIFT button is used with other buttons that have shift modifier functions.

#	Slate 4 Control	Serato DJ Function
1	KENSINGTON LOCK	Used to secure your controller (lock not included)
2	USB	Connect the Gemini Slate 4 to your computer via USB cable
3	MASTER	Master RCA output to speakers
4	HEADPHONES	1/8" headphone output
5	CUE MIX	Adjust Cue/PGM mix
6	MIC VOL	Adjust Mic volume
7	MIC	1/4" MIC input

Performance Pads

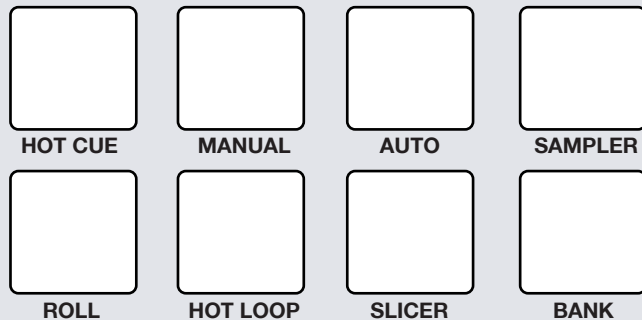

The performance pads have eight different modes you can select. **HOT CUE, MANUAL, AUTO, SAMPLER, ROLL, HOT LOOP, SLICER, and BANK.**



- **HOT CUE Mode:**
Press pads 1-8 to add/trigger cue points. Holding SHIFT and pressing pads 1-8 will delete cue points.
- **MANUAL Mode:**
Use this mode to set manual loops. Pressing pad 1 will start set a Manual Loop In point, pad 2 will set the Loop Out point. If the loop is active hitting pad 1 or 2 will let you adjust the In/Out points of the loop. Pad 3 will turn loop ON/OFF. Pad 4 will half the current loop size. Pad 7 will turn the Loop On/Off and Retrigger the loop and Pad 8 will double the current loop, Pads 5 and 6 are not used.
- **AUTO Mode:**
In **AUTO** mode, pressing pads 1-8 will activate Auto Loops of different sizes. Press pad again to turn loop off.

- **SAMPLER Mode:**
Trigger SP-6 samples using pads 1-6. Pads 7 and 8 are not used.
- **ROLL Mode**
Pressing pads 1-8 will set loop rolls of specified length as long as the pad is held. The track will slip and continue playing from original play-head position when you lift your finger off the pad.
- **HOT LOOP Mode**
Hot loop mode will allow you to engage a set loop from the cue points you have set. Press pad once to jump to that cue point and set a loop. The loop size can be toggled on the virtual deck in the loop size area. Pressing the pad again will turn the loop off. Hold **SHIFT** and press pad to re-trigger the Cue Point with the loop on.
- **SLICER Mode**
A specified range (or domain) is divided into eight equal sections, and these eight sliced sections are assigned to the respective performance pads. Holding Pad Mode and pressing **SLICER** once for the first mode, is a shifting Slicer Domain. Pressing **SLICER** twice, for the second mode is a fixed Slicer Domain or "loop". Use the **PARAMETER** knob to set the quantization for the slicer function. The quantization can be set in four ways: 1/8, 1/4, 1/2 and 1. **SHIFT** + **PARAMETER** knob will set the domain. The domain can be set to one of six settings: 2 beats, 4 beats, 8 beats, 16 beats, 32 beats or 64 beats.
- **BANK Mode**
When in BANK mode, pads 1-4 control SP-6 sample banks while pads 5-8 control SP-6 output channels.

DJ-FX

The DJ-FX in Serato DJ are powered by iZotope™. Click the FX tab to open the FX panel. Select either 1, 2 or M to assign the selected effect bank to a deck or Master Output. To activate an effect, click the **ON** button on your FX UNIT in the software, or the **FX** button on your controller.

There are two available modes in the DJ-FX. Single FX Mode allows you to select one effect per FX bank, and has multiple parameters that can be adjusted. Multi FX Mode allows you to select up to three effects per FX bank, and adjust only one parameter, the FX Depth. The same effects available in Single FX mode are available in Multi FX mode, as well some additional presets.

You can select between the two FX modes by clicking either the Single FX mode button  or Multi FX mode button .

Slate 4 Control	Single FX Mode	Multi FX Mode	Shift
FX 1	Turn Effect On	Slot 1 Effect On/Off	Select slot effect
FX 2	Adjust FX Parameter 2	Slot 2 Effect On/Off	Select slot effect (Multi FX)
FX 3	Adjust FX Parameter 3	Slot 3 Effect On/Off	Select slot effect (Multi FX)
Level	Adjust FX 1 level	Adjust all FX level	Adjust Beats Multiplier

The effect time is set using the tracks BPM value, but by applying the Beats Multiplier you can increase or decrease the effect timing.

Looping

You have the choice of Auto or Manual Looping within Serato DJ with the Gemini Slate 4. In **AUTO** pad mode, pressing pads 1-8 will activate Auto Loops of different sizes. Press pad again to turn loop off. Manual looping details are listed below. **SEE PERFORMANCE PADS FOR MORE INFORMATION**

NOTE You can also save a loop to the next available free loop slot in the software. To do this, click  on an available loop slot. Your loops are saved to the file and recalled the next time it is loaded. They are not lost if the file is moved or renamed.

Slate 4 Control	Manual Loop Mode
Pad 1	Set Manual loop in point (Loop not active) Adjust loop in point (Loop active)
Pad 2	Set Manual loop out point (If loop in point is set) Adjust loop out point (Loop active)
Pad 3	Exit Loop (Loop Active) Loop on (Loop not active)
Pad 4	Press to halve the loop length (1/2)
Pad 5	N/A
Pad 6	N/A
Pad 7	Turn Loop On/Off / Retrigger Loop
Pad 8	Press to double the loop length (x2)

NOTE: The best way to edit the in and out points of a manual loop is with the jog wheel/platter on your Slate 4.

Serato Video

Serato Video is an Expansion Pack for Serato Software which adds the ability to playback and mix video files, use effects and fader transitions with your Serato DJ hardware, an additional MIDI controller or your mouse/keyboard.

For more information on Serato Video go to <http://serato.com/video>

MIDI

The MIDI control feature in Serato DJ provides the ability to map Serato DJ software functions to MIDI controller functions such as keyboards, triggers, sliders, and knobs. Integrating MIDI controllers into your Serato DJ setup can improve live performance usability, such as hitting pads on a MIDI controller to trigger Loops and Cue Points.

For more information download the Serato DJ manual by going to <http://serato.com/dj/downloads>

NOTE: You can not MIDI Map your Gemini Slate 4, you will need to connect an additional MIDI controller to use these MIDI functions.

Using the Tool Tips

Click on the  icon to enable Tool Tips. This is located in between the MIDI and setup button in the top right hand corner of the screen. Tool Tips provide a handy way to learn the various features of Serato DJ.

Move the mouse over a section of the screen to bring up a context sensitive tool tip. Holding the mouse over the  button with Tool Tips turned on will show you a list of all keyboard shortcuts.

For more information about how to use Serato DJ, please go to our website www.serato.com or refer to the Serato DJ Software Manual.

For more information on your controller, please refer to the hardware manual.

For further help, please contact support@serato.com or go to www.serato.com/dj/support

serato

